

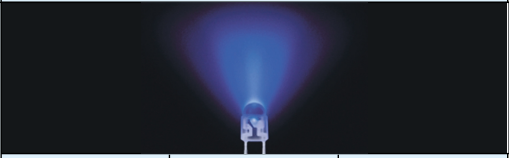

# High Brightness Type $\phi 3.1$ Circular Type LED Lamps (LEDs with Pressure Release Structure)

## SLR343 Series

Pressure Release

Shape	Emitting Surface Dimension (mm)	Blue			Green	
		InGaN on SiC				
		468nm		523nm	518nm	
Circular Type	$\phi 3.1$					
		SLR343BBT	SLR343BCT	SLR343BDT	SLR343EBT	SLR343ECT

Note) "\*" will be taken out for emitting color B/E series.

### Absolute Maximum Ratings (Ta=25°C)

Part No.	Emitting color	Power dissipation Pd (mW)	Forward current IF (mA)	Peak forward current * I <sub>FP</sub> (mA)	Reverse voltage VR (V)	Operating temperature T <sub>opr</sub> (°C)	Storage temperature T <sub>stg</sub> (°C)
SLR343BBT	Blue	120	30	100	5	-20 to +80	-30 to +100
SLR343BCT							
SLR343BDT							
SLR343EBT	Green	120	30	100	5	-20 to +80	-30 to +100
SLR343ECT							
SLR343EDT							

\* I<sub>FP</sub> measured under duty  $\leq 1/10, 1\text{kHz}$

### External Dimensions (Unit : mm)

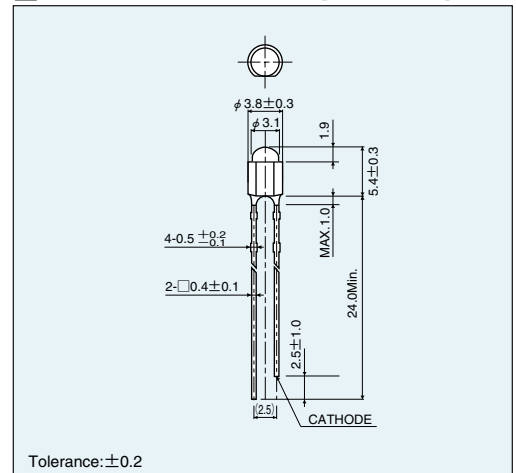

### Electrical Optical Characteristics (Ta=25°C)

Part No.	Resin Color	Forward voltage VF		Reverse current IR		Light wavelength			Brightness Iv		
		Typ. (V)	IF (mA)	Max. (μA)	VR (V)	Peak $\lambda_p$ (nm)	Half-wave $\Delta\lambda$ (nm)	IF (mA)	Min. (mcd)	Typ. (mcd)	IF (mA)
SLR343BBT	Transparent Clear	3.5	20	100	5	468	26	20	90	350	20
SLR343BCT									200	600	
SLR343BDT									300	800	
SLR343EBT		3.8	20	100	5	523	36	20	420	1500	
SLR343ECT									610	2000	
SLR343EDT	900	3500									

### Directivity

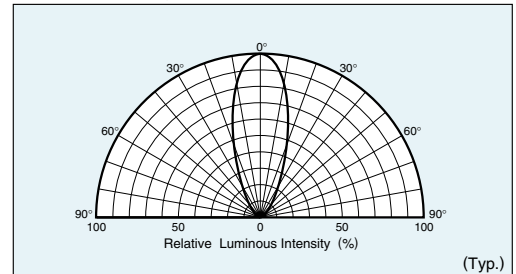

### Recommended Pad Layout

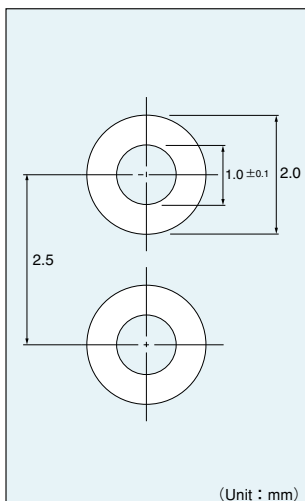

### Packaging Specifications (Unit : mm)

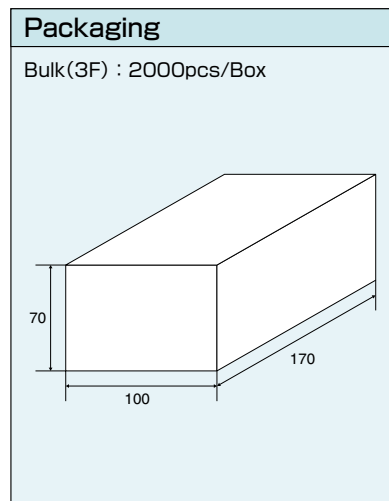

## Electrical Characteristic Curves

### Forward Current - Forward Voltage

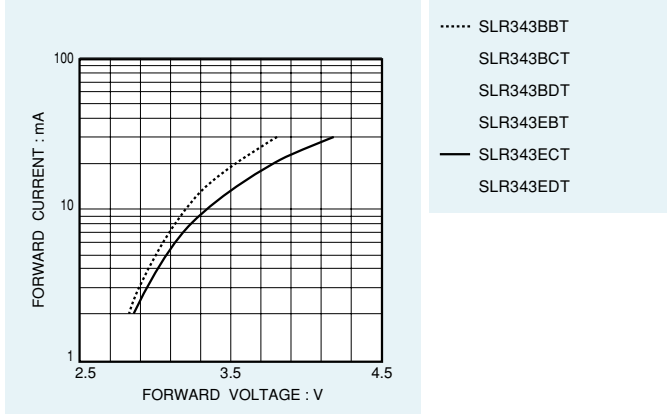

### Relative Luminous Intensity - Case Temperature

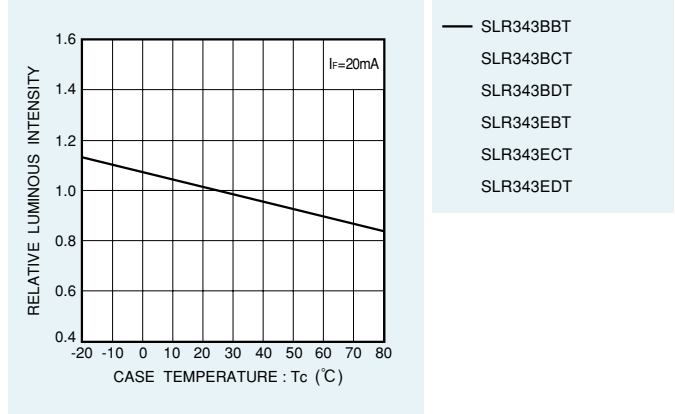

### Relative Luminous Intensity - Forward Current

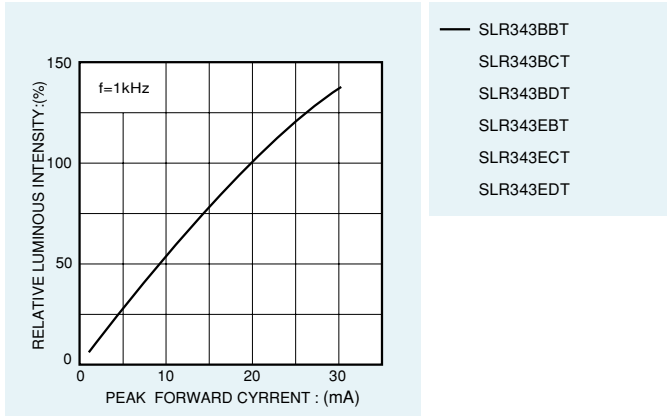

### Ratio of Maximum Tolerable Peak Current - Pulse Duration

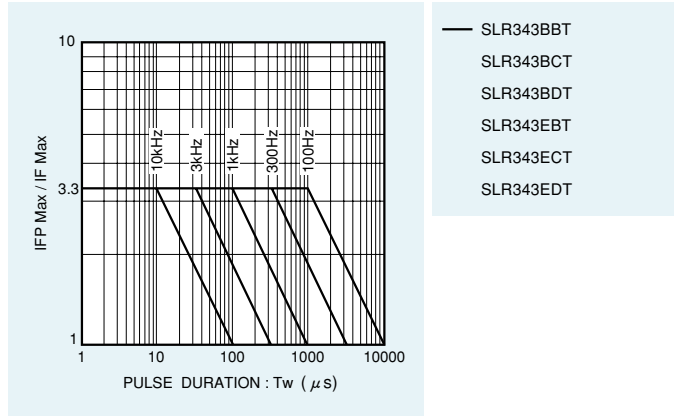

## Derating

